

S3006P/3008P/3010P

PUSH-AROUND MINI SCISSOR LIFTS



- Lightweight and compact
- Easily passes through a standard doorway
- No outriggers or stabilisers required
- Durable design for tough site conditions
- Proven benefits over other low level access products:
 - better job site productivity
 - safer and more convenient working conditions
 - better return on investment (ROI) for rental/hire companies

 **snorkel**
www.snorkellifts.com

PUSH-AROUND MINI SCISSOR LIFTS

S3006P 3008P/3010P

DIMENSIONS	S3006P	S3008P	S3010P
Max. working height	4.0m	4.5m	5.0m
Max. platform height (A)	2.0m	2.5m	3.0m
Overall width (B)	0.75m	0.75m	0.75m
Overall length (C)	1.2m	1.2m	1.2m
Stowed height (D)	1.7m	1.8m	1.8m

PERFORMANCE	S3006P	S3008P	S3010P
Platform capacity (SWL)	240kg	240kg	240kg
Max. wind speed	0m/s	0m/s	0m/s
Raise/lower time	8/14 sec	13/17 sec	19/26 sec

POWER	S3006P	S3008P	S3010P
Power source	12V DC battery		
Charger	Built in multi-voltage (90V - 240V)		

WEIGHT	S3006P	S3008P	S3010P
Weight	310kg	350kg	370kg

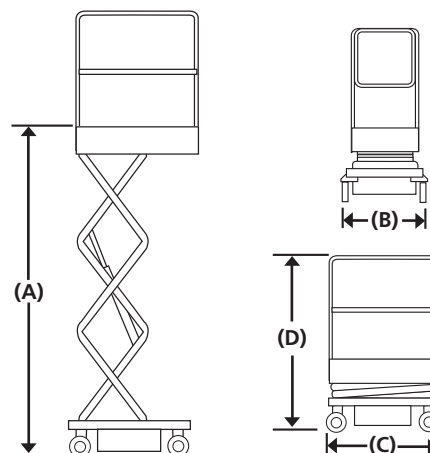

STANDARD FEATURES

- Auto brake system
- Tilt sensor
- Saloon-door style entry gates
- Integrated battery charger 90V-240V
- Battery charge indicator
- Forklift pockets
- Emergency lowering system
- Non-marking casters
- Slide-out service trays
- 2 year parts & labour, 5 year structural warranty
- CE approved

OPTIONS

- Special paint colours
- Environmental hydraulic oil

PLATFORM HEIGHTS

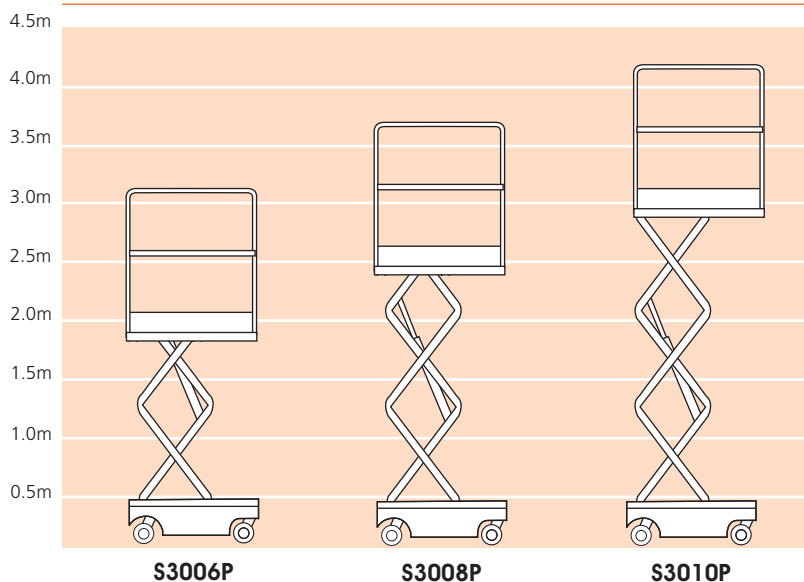

snorkel www.snorkellifts.com

Vigo Centre, Birtley Road,
Washington, Tyne & Wear,
NE38 9DA, U.K.

t: +44 (0) 845 1550 057
e: sales@snorkellifts.com